

2010 Catalog



HAWEKA®



Distributed By:



WHEEL BALANCING ADAPTORS

HAWEKA USA Inc. 181 Johns Road - Suite H • Greer, SC 29650

P: 866.442.9352 F: 866.770.3239

www.haweke-usa.com

Terms and Conditions of Sale

General: Terms and conditions described shall apply to products sold by Allpart Supply Inc./Haweka USA to the purchaser.

Delivery: Delivery of products shall be considered complete at time of shipment from Allpart Supply/Haweka USA's warehouse. All shipments are FOB from the company's plant in Fort Worth, Texas or from the company's plant in Greer, South Carolina. Ownership will pass to the purchaser at time of pick up by carrier from the company's shipping location. Products will be shipped by a carrier of Allpart Supply/Haweka USA's choosing. CREDIT WILL NOT BE ISSUED TO THE PURCHASER FOR FREIGHT CHARGES DUE TO THE FAILURE OF CARRIER TO DELIVER TO THE CUSTOMER'S EXPECTATIONS UNTIL OR UNLESS ALLPART SUPPLY/HAWEKA USA IS ABLE TO OBTAIN CREDIT FIRST. NO LABOR CHARGES, MILEAGE CHARGES OR OTHER LOSS SHALL BE PAID BY ALLPART SUPPLY FOR LATE OR MISSED DELIVERIES.

Warranties: Allpart Supply/Haweka USA guarantees its products to be free of defects in material and workmanship for 90 days. The company's liability is limited to invoice price of the product or replacement part free of charge at the company's discretion. Liability for defects does NOT extend to labor or consequential damages.

Product Disclaimer: All products sold by Allpart Supply/Haweka USA are intended as replacement parts for the original equipment.

Alterations & Indemnification: Allpart Supply/Haweka USA's parts are designed for specific applications and uses. As such, parts should not be altered or modified in any way. Nor shall any parts supplied by the company be used in applications other than their original designed application. Modifications and alterations to parts supplied by the company void the warranty and disqualify the part from store credit. Purchaser shall indemnify and agree to hold harmless Allpart Supply/Haweka USA from all liabilities and expenses that arise from product used outside of design criteria, or modified or altered parts.

Freight: Orders are shipped FOB the company's warehouse in Fort Worth, Texas or the company's warehouse in Greer, South Carolina. Freight and COD charges will be added to the invoice at time of shipment.

Return Policy: All returned product must be accompanied by an RGA number (Returned Goods Authorization) to be obtained from the company prior to return. Place an RGA # on the outside of the return container in a visible location. Parts must be returned freight prepaid by the purchaser.

Restocking Fee and Credit: A 15% restocking fee will be applied to all returned products. The balance of the credit will be applied to purchaser for store credit. Purchaser is responsible for all return freight. Shipments that are refused shall also be subject to the restocking fees and freight charges.

Allpart Supply, Inc./Haweka USA Accepts: Visa, Mastercard, Discover, American Express or COD. Prices are subject to change without notice.

Application of Law: All sales orders and invoices shall be governed by Texas law in place on the date of the invoice.

THE HAWEKA PHILOSOPHY

Create more precise and repeatable balancing results by determining the wheel mounting situation from any vehicle and replicate it onto the balancer. This is the driving force behind the HAWEKA line of adaptors.



Precision Is Our Goal

TABLE OF CONTENTS

Description	Page(s)
PROGRIP QUICKNUT SECTION	3 - 13
ProGrip QuickNuts Accessories and Repair	14
Balancer Shafts	15 - 16
Standard Taper Cones / Light Truck Kits	17
Low Taper Cones / Set of Gauges and Measuring Devices	18
Manufacturer Specific Adaptors	19 - 20
PASSENGER CAR, LIGHT TRUCK AND SUV SECTION	21
Duo Collets	22
Pro Expert Kit (Formerly the Universal Kit)	23
QuickPlates Kit for Standard Threaded Shafts	24
Individual QuickPlates for Threaded Shafts	25
QuickPlates Kit for Power Clamp Shafts	26
Individual QuickPlates for Power Clamp Shafts	27
Duo Plate Kits	28
Individual Duo Plates	29
Tips for Duo Plates and QuickPlates	30
Individual Color Coded Flange Plates	31
U.S. Flange Plate Kit	32
Individual U.S. Flange Plates	33
General Options and Accessories	34
MEDIUM DUTY SECTION	35
ProMax Adaptor Kits and Adaptor Spare Parts	36 - 39
AirGo Lift (Wheel Lift)	40
SEMI TRUCK / BUS ADAPTORS SECTION / Kits and Accessories	41 - 46
MOTORCYCLE SECTION / ProBike Kits	47 - 49
Motorcycle Accessories and Upgrades	50
Bolt Patterns List	51
WHEEL ALIGNMENT CLAMPS	52 - 53

NEW! See page 51 for bolt pattern reference guide. NEW!

NOT SURE WHICH QUICKNUT HANDLE WILL WORK ON YOUR BALANCER?

Take the guesswork out of it completely with HAWEKA'S shaft Gauge. This tool will help you determine the exact shaft diameter and pitch for any balancer, making it simple for everyone to find the correct Quicknut handle for any application. This tool includes diameter and pitch templates for virtually every balancer shaft on the U.S. market.

Part # 900 008 108

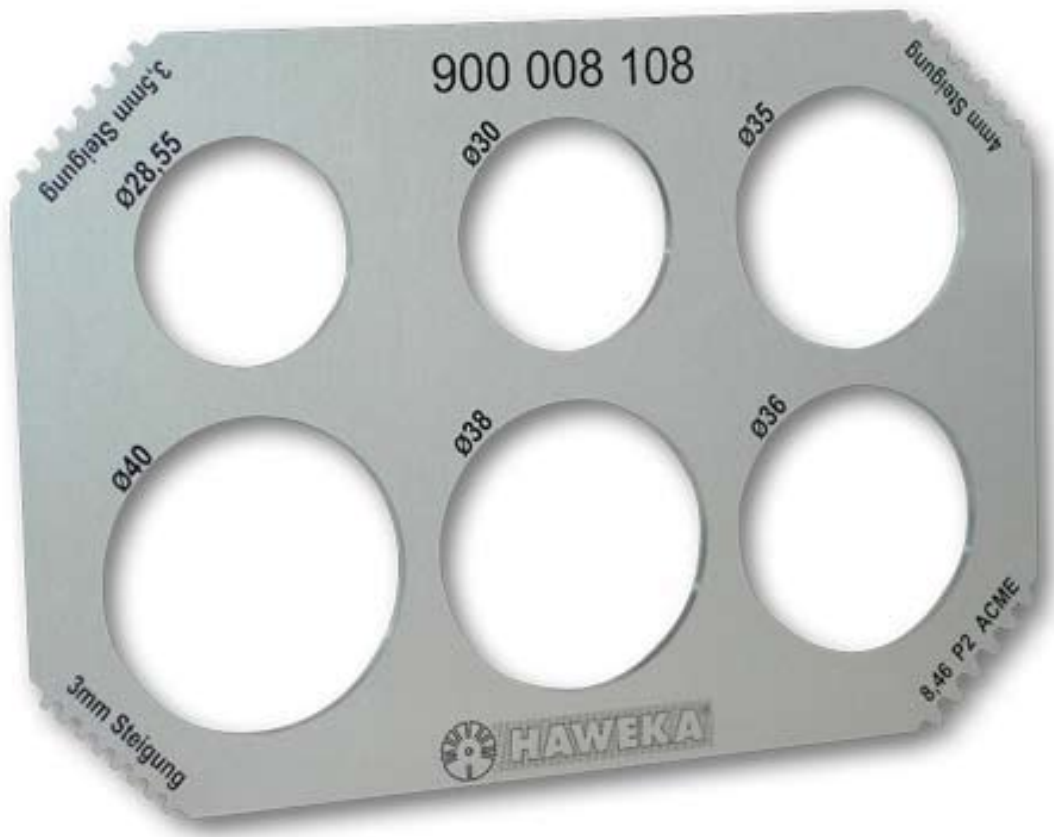





(Gauge located on page 15)

ACCUTURN®

Models: 1200,1220, 1250, 1400, 1420, 1450, 1500, 1520, 1550, 1650,1820 and 1850.

Shaft: 40mm
(Clamping hoods sold separately)

Drawing	Description	Part #
	ProGrip QuickNut OPTION 1	143 404 003
	ProGrip QuickNut w/ turning knobs OPTION 2	143 404 006
	Steel ProGrip QuickNut OPTION 3	140 404 033
	WingNut OPTION 4	140 404 101

PROGRIP QUICKNUT SECTION





Models: 5100, 5223, 5500 and 5600 Serial # 51-0623 and lower

Shaft: 28mm

	ProGrip QuickNut Kit for Accuturn® Includes QuickNut, clamping hood & 28mm shaft	124 597 050
------------------------------------------------------------------------------------	--------------------------------------------------------------------------------------------	--------------------

Models: *5100, 5223, 5500 & 5600 Serial # 51-0623 thru 51-1457

Shaft: 40mm
(Clamping hoods sold separately)

	ProGrip QuickNut OPTION 1	143 403 003
	ProGrip QuickNut w/ turning knobs OPTION 2	143 403 006
	Steel ProGrip QuickNut OPTION 3	140 403 033
	WingNut OPTION 4	140 403 101





*NOTE: Accuturn 5100, 5223, 5500 & 5600 models changed shaft diameters during mid-production. These models started production with a 28 mm shaft then changed to a 40 mm shaft. The shaft diameter for these models must be verified before ordering.
(See Kit for the 5100, 5223, 5500 & 5600 28mm options)

ACCUTURN®

PROGRIP QUICKNUT SECTION



All Models 5800 & 6000.

Shaft: 40mm
(Clamping hoods sold separately)





Drawing	Description	Part #
	ProGrip QuickNut OPTION 1	143 403 003
	ProGrip QuickNut w/ turning knobs OPTION 2	143 403 006
	Steel ProGrip QuickNut OPTION 3	140 403 033
	WingNut OPTION 4	140 403 101

Models: 6100, 6600, 6700 and 6800

Shaft: 36mm
(Clamping hoods sold separately)





	ProGrip QuickNut OPTION 1	143 363 003
	ProGrip QuickNut w/ turning knobs OPTION 2	143 363 006

BEISSBARTH®



Models: All Models		Shaft: 40mm (Clamping hoods sold separately)
Drawing	Description	Part #
	<i>ProGrip QuickNut</i> OPTION 1	143 403 003
	<i>ProGrip QuickNut w/ turning knobs</i> OPTION 2	143 403 006
	<i>Steel ProGrip QuickNut</i> OPTION 3	140 403 033
	<i>WingNut</i> OPTION 4	140 403 101

PROGRIP QUICKNUT SECTION

BOSCH

Models: All Models		Shaft: 40mm (Clamping hoods sold separately)
Drawing	Description	Part #
	<i>ProGrip QuickNut</i> OPTION 1	143 404 003
	<i>ProGrip QuickNut w/ turning knobs</i> OPTION 2	143 404 006
	<i>Steel ProGrip QuickNut</i> OPTION 3	140 404 033
	<i>WingNut</i> OPTION 4	140 404 101





CEMB

Models: All Models prior to 1995		Shaft: 36mm (Clamping hoods sold separately)
Drawing	Description	Part #
	<i>ProGrip QuickNut</i> OPTION 1	143 363 003
	<i>ProGrip QuickNut w/ turning knobs</i> OPTION 2	143 363 006

Models: All Models 1995 and later

Shaft: 40mm
(Clamping hoods sold separately)

PROGRIP QUICKNUT SECTION

Drawing	Description	Part #
	ProGrip QuickNut OPTION 1	143 404 003
	ProGrip QuickNut w/ turning knobs OPTION 2	143 404 006
	Steel ProGrip QuickNut OPTION 3	140 404 033
	WingNut OPTION 4	140 404 101

**PRODUCING THE
HIGHEST QUALITY
QUICKNUTS FOR
OVER 25 YEARS!!**







HAWEKA[®]
USA

Models: 700, 800, 825, 850, 925, 950, 1000, 1025, 1050, 1055, & 1250

With OEM 28mm shaft		Models: 700, 800, 825, 850, 925, 950, 1000, 1025, 1050, 1055, & 1250	Shaft: 28mm
Drawing	Description	Part #	
	<p>ProGrip QuickNut kit for Coats®</p> <p>Replaces OEM shaft and nut</p> <p>Includes QuickNut, clamping hood & shaft</p>	124 937 003	
	<p>28mm to 40 mm Conversion shaft kit for Coats® balancers</p> <p>Provides larger shaft to support alloy wheels</p> <p>Includes QuickNut, clamping hood, upgrade shaft, spring & 4 piece cone kit.</p> <p style="color: red; text-align: right;">*(Post March 1992 balancers only)</p>	124 937 150	
	<p>ProGrip QuickNut</p> <p>For 28mm aftermarket Haweka replacement shaft only. Will not work on OEM shaft. (Clamping hoods sold separately)</p>	143 283 003	
Previously upgraded to OEM 40mm shaft		Models: 700, 800, 825, 850, 925, 950, 1000, 1025, 1050, 1055, & 1250	Shaft: 40mm (Clamping hood included)
	<p>Steel ProGrip QuickNut</p> <p style="text-align: right;">OPTION 1</p>	124 408 005	
	<p>WingNut</p> <p style="text-align: right;">OPTION 2</p>	140 408 101	
Previously upgraded to Haweka brand 40mm shaft		Models: 700, 800, 825, 850, 925, 950, 1000, 1025, 1050, 1055, & 1250	Shaft: 40mm (Clamping hoods sold separately)
	<p>ProGrip QuickNut</p> <p style="text-align: right;">OPTION 1</p>	143 403 003	
	<p>ProGrip QuickNut w/ turning knobs</p> <p style="text-align: right;">OPTION 2</p>	143 403 006	
	<p>Steel ProGrip QuickNut</p> <p style="text-align: right;">OPTION 3</p>	140 403 033	
	<p>WingNut</p> <p style="text-align: right;">OPTION 4</p>	140 403 101	





Models: 775, 875, 1175, and 6275HS

Shaft: 40mm
(Clamping hood included)

Drawing	Description	Part #
	Steel ProGrip QuickNut OPTION 1	124 408 005
	WingNut OPTION 2	140 408 101

Models: XR Balancers

Shaft: 40mm
(Clamping hoods sold separately)

	ProGrip QuickNut OPTION 1	143 404 003
	ProGrip QuickNut w/ turning knobs OPTION 2	143 404 006
	Steel ProGrip QuickNut OPTION 3	140 404 033
	WingNut OPTION 4	140 404 101

Models: 6200HS

Shaft: 28mm
(Clamping hoods sold separately)

	ProGrip QuickNut w/ turning knobs	143 285 006
-------------------------------------------------------------------------------------	------------------------------------------	-------------

Order a shaft gauge for correct shaft identification.

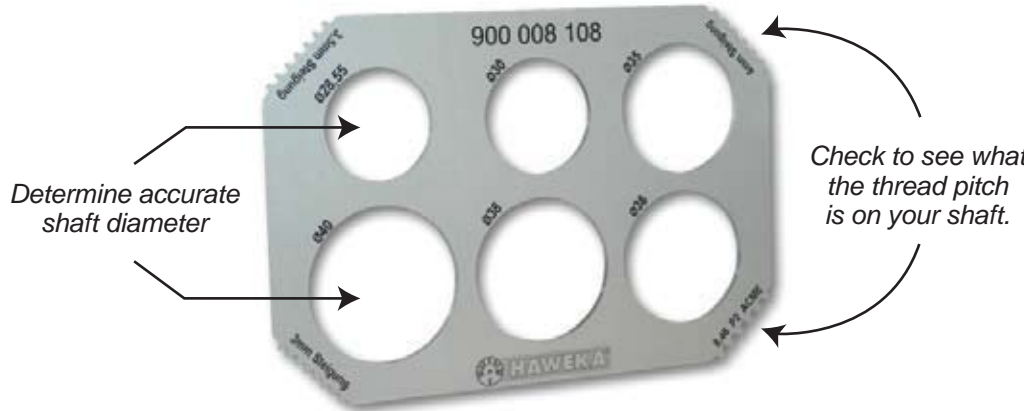

Determine accurate shaft diameter

Check to see what the thread pitch is on your shaft.



900 008 108

Great for determining which Coats® shaft you have.





Shaft Gauge

900 008 108

Models: All Models prior to 2007 **38mm** **Shaft: 38mm**
(Clamping hoods sold separately)



Drawing	Description	Part #
	<i>ProGrip QuickNut</i> OPTION 1	143 383 003
	<i>ProGrip QuickNut w/ turning knobs</i> OPTION 2	143 383 006

Models: All Models 2007 and later **40mm** **Shaft: 40mm**
(Clamping hoods sold separately)

	<i>ProGrip QuickNut</i> OPTION 1	143 403 003
	<i>ProGrip QuickNut w/ turning knobs</i> OPTION 2	143 403 006
	<i>Steel ProGrip QuickNut</i> OPTION 3	140 403 033
	<i>WingNut</i> OPTION 4	140 403 101

COSENG / ATLAS

Models: C301, C311, 322, and C366 **Shaft: 36mm**
(Clamping hoods sold separately)

Drawing	Description	Part #
	<i>ProGrip QuickNut</i> OPTION 1	143 363 003
	<i>ProGrip QuickNut w/ turning knobs</i> OPTION 2	143 363 006

PROGRIP QUICKNUT SECTION

FMC / JOHN BEAN[®]

PROGRIP QUICKNUT SECTION

Models: All Models





Shaft: 40mm
(Clamping hoods sold separately)

Drawing	Description	Part #
	ProGrip QuickNut OPTION 1	143 404 003
	ProGrip QuickNut w/ turning knobs Required for Hand Spin Models OPTION 2	143 404 006
	Steel ProGrip QuickNut OPTION 3	140 404 033
	WingNut OPTION 4	140 404 101

HOFMANN[®]

Models: All Models



Shaft: 40mm OEM
(Clamping hoods sold separately)

Drawing	Description	Part #
	ProGrip QuickNut OPTION 1	143 404 003
	ProGrip QuickNut w/ turning knobs OPTION 2	143 404 006
	Steel ProGrip QuickNut OPTION 3	140 404 033
	WingNut OPTION 4	140 404 101

HUNTER®

Models: 700 and DSP9500 from 1990 - 1992

Shaft: 40mm
(Clamping hoods sold separately)

Drawing	Description	Part #
	ProGrip QuickNut OPTION 1	143 403 003
	Steel ProGrip QuickNut OPTION 2	140 403 033
	WingNut OPTION 3	140 403 101

Models: All other balancers



Shaft: 40mm
(Clamping hood included)

	Steel ProGrip QuickNut	124 408 005
-----------------------------------------------------------------------------------	-------------------------------	-------------

LAUNCH

Models: All Models



Shaft: 36mm OEM
(Clamping hoods sold separately)

Drawing	Description	Part #
	ProGrip QuickNut OPTION 1	143 363 003
	ProGrip QuickNut w/ turning knobs OPTION 2	143 363 006

RANGER

Models: DST-1000 and R-1500

Shaft: 36mm OEM
(Clamping hoods sold separately)

Drawing	Description	Part #
	ProGrip QuickNut OPTION 1	143 363 003
	ProGrip QuickNut w/ turning knobs OPTION 2	143 363 006





PROGRIP QUICKNUT SECTION

SICAM

PROGRIP QUICKNUT SECTION

Models: All Models

Shaft: 40mm
(Clamping hoods sold separately)

Drawing	Description	Part #
	<i>ProGrip QuickNut</i> OPTION 1	143 403 003
	<i>ProGrip QuickNut w/ turning knobs</i> OPTION 2	143 403 006
	<i>Steel ProGrip QuickNut</i> OPTION 3	140 403 033
	<i>WingNut</i> OPTION 4	140 403 101

SNAP ON®





Models: All models with 28mm shafts

Shaft: 28mm
(Clamping hoods sold separately)

Drawing	Description	Part #
	<i>ProGrip QuickNut w/ turning knobs</i>	143 285 006

Models: All models with 40mm shaft

Shaft: 40mm
(Clamping hoods sold separately)

	<i>ProGrip QuickNut</i> OPTION 1	143 404 003
	<i>ProGrip QuickNut w/ turning knobs</i> OPTION 2	143 404 006
	<i>Steel ProGrip QuickNut</i> OPTION 3	140 404 033
	<i>WingNut</i> OPTION 4	140 404 101

Replacement Kit for 28mm shaft

Drawing	Description	Part #
	<p>ProGrip QuickNut kit for Snap On 28mm</p> <p>Replaces OEM shaft and nut</p> <p>Includes QuickNut, clamping hood & shaft</p>	<p>124 957 050</p>

Models: All 28mm previously upgraded to Haweka shaft

Shaft: 28mm
(Clamping hoods sold separately)

	<p>ProGrip QuickNut</p>	<p>143 283 003</p>
-----------------------------------------------------------------------------------	--------------------------------	---------------------------



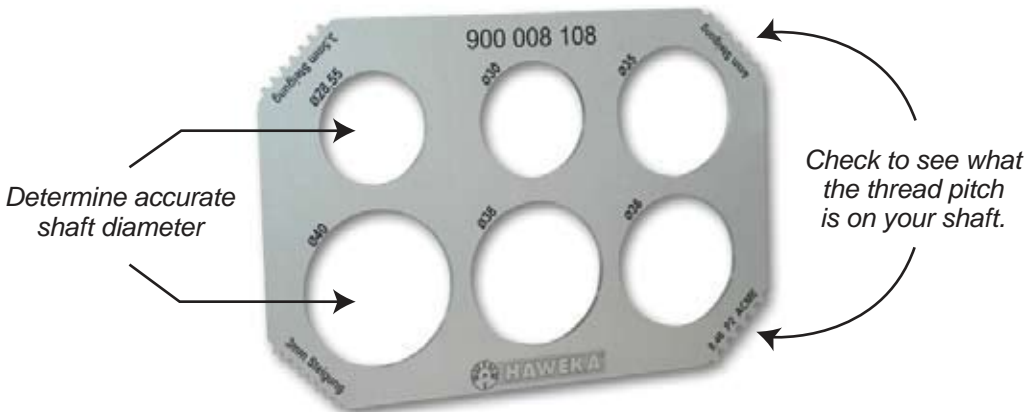

Upgrade: 28mm to 40mm Conversion Shaft Kit

	<p>28mm to 40 mm Conversion shaft kit for Snap On balancers</p> <p>Provides larger shaft to support alloy wheels</p> <p>Includes QuickNut, clamping hood, upgrade shaft, spring & 4 piece cone kit.</p>	<p>124 957 150</p>
------------------------------------------------------------------------------------	--------------------------------------------------------------------------------------------------------------------------------------------------------------------------------------------------------------------	---------------------------

Order a shaft gauge for correct shaft identification.

 <p>Determine accurate shaft diameter</p> <p>Check to see what the thread pitch is on your shaft.</p> <p>Great for determining which Snap On® shaft you have.</p>	<p>Shaft Gauge</p> <p>900 008 108</p>
--------------------------------------------------------------------------------------------------------------------------------------------------------------------------------------------------------------------------------------------------------------	-----------------------------------------------------

PROGRIP QUICKNUT ACCESSORIES & REPAIR

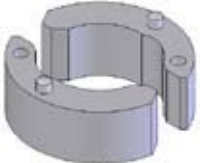
Drawing	Description	Part #	
	5" Standard Clamping Hood (Fits ALL Haweka Quick Nuts)	190 008 002	
	Rubber Cover for 5" Standard clamping hood	190 008 005	
	8" Clamping hood with rubber lip for alloy rims (Fits ALL Haweka Quick Nuts)	190 008 021	
	Pressure Ring (Fits ALL Haweka Quick Nuts)	190 008 027	
	Repair Kit for ProGrip QuickNuts	28 mm x 3 mm	141e283 310
		28 mm x 3.5 mm	141e285 310
		28 mm x 8 mm	141e288 310
		36 mm x 3 mm	141e363 310
		38 mm x 3 mm	141e383 310
		40 mm x 3 mm	141e403 310
		40 mm x 4 mm	141e404 310
		40 mm x 8 mm	141e408 310
	Replacement Jaws for ProGrip QuickNuts	28 mm x 3 mm	140e283 302
		28 mm x 3.5 mm	141e285 302
		28 mm x 8 mm	140e288 302
		36 mm x 3 mm	140e363 302
		38 mm x 3 mm	140e383 302
		40 mm x 3 mm	140e403 302
		40 mm x 4 mm	140e404 302
		40 mm x 8 mm	140e408 302

BALANCER SHAFTS



Drawing	Description	Part #
	Shaft O.D. Gauge (Measures shaft diameter & thread pitch)	900 008 108
 <p>40mm x 3mm</p>	9.5" Threaded Shaft for Coats® (Post March 1992 balancers only) Fits Models: 700, 825, 850, 925, 950, 1000, 1025, 1050, 1055, 1250	170 937 002
 <p>28mm x 8mm</p>	8.5" Threaded Shaft for Coats® Fits Models: 650, 700, 800, 825, 850, 925, 950, 1000, 1001, 1004, 1025, 1050, 1055, 1250	170 937 006
 <p>28mm x 3mm</p>	8.5" Threaded Shaft for Coats® Fits Models: 650, 700, 800, 825, 850, 925, 950, 1000, 1001, 1004, 1025, 1050, 1055, 1250	170 937 001
 <p>38mm x 3mm</p>	10" Threaded Shaft For Corghi®	170 907 004
 <p>40mm x 4mm</p>	10" Threaded Shaft for Snap-On® / John Bean® Fits JBC model: 3.5 & 5.7 28mm to 40 mm Conversion shaft for Snap On balancers	170 958 002
 <p>28mm x 3 mm</p>	10" Threaded Shaft for Snap-On®	170 957 002
 <p>28mm x 3.5mm</p>	9.25" Threaded Shaft for Snap-On®	170 957 011
 <p>40mm x 4mm</p>	10" Threaded Shaft Super long for FMC Series 4100 / 5800 & 5.1	170 827 002
 <p>40mm x 3mm</p>	13" Threaded Shaft for Hunter®	170 617 002

BALANCER SHAFTS









All measurements listed are the overall length of the shaft from tip to tip, including threads.

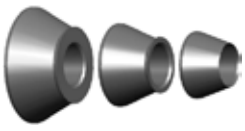
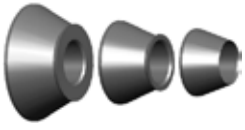
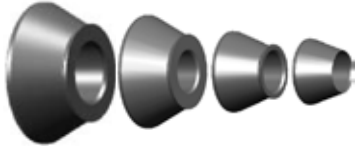
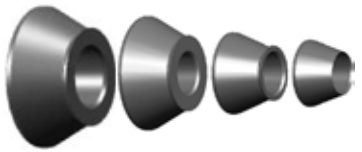

BALANCER SHAFTS

Drawing	Description	Part #
	<p>ProGrip QuickNut kit for Accuturn®</p> <p>Includes QuickNut, Clamping hood & shaft Shaft has the Haweka thread pitch (28 mm x 3 mm)</p>	<p>124 597 050</p>
	<p>ProGrip QuickNut kit for Coats®</p> <p>Includes QuickNut, Clamping hood & shaft Shaft has the Haweka thread pitch (28 mm x 3 mm) Offers more shaft to adapter contact surface than the stock thread pitch.</p>	<p>124 937 003</p>
	<p>Upgrade kit for Coats®</p> <p>Includes QuickNut, Clamping hood, upgrade shaft, spring & 4 piece 150 400 070 cone kit. Shaft has the Haweka thread pitch. (40 mm x 3 mm) <u>(Post March 1992 balancers only)</u></p> <p>Fits Models: 700, 825, 850, 925, 950, 1000, 1025, 1050, 1055, 1250</p>	<p>124 937 150</p>
	<p>28mm to 40 mm Conversion shaft kit for Snap On balancers</p> <p>Snap On upgrade kit (40 mm)</p> <p>Includes QuickNut, Clamping hood, upgrade shaft, spring & 4 piece 150 400 070 cone kit (40 mm x 4 mm)</p>	<p>124 957 150</p>
	<p>Basic Centering Device for Sicam/Beissbarth <u>Extended length</u> 9.5" shaft Factory Thread Pitch 40 x 3</p>	<p>100e818 040</p>
	<p>Basic Centering Device for Select Hunter Models Standard length 8" shaft Factory Thread Pitch 40 x 8</p>	<p>100e999 070</p>
	<p>Universal Distance Spacer With Magnets Used on most Off- Road applications Used to back cone wheels with a high offset</p>	<p>190e008 047</p>
	<p>Donut for Distance Spacer</p>	<p>40 mm 190e400 045 38 mm 190e380 045 36 mm 190e360 045 28 mm 190e280 045</p>

STANDARD TAPER CONES

Drawing	Description	Shaft Size	Part #
	3 Piece Centering Cone Set 1.65"- 4.39" 42mm – 111.5mm	28 mm	150 280 085
		36 mm	150 360 085
		38 mm	150 380 085
		40 mm	150 400 085
	3 Piece Centering Cone Set 1.65"- 3.94" 42mm – 100mm	28 mm	150 280 021
		36 mm	150 360 021
		38 mm	150 380 021
		40 mm	150 400 021
Recommended on Coats® balancers for maximum coverage			
	4 Piece Centering Cone Set 1.65"- 5.20" (42mm – 132mm) <i>Tacoma Cone Included</i> <i>Includes Cones: 1, 2, 4 & 5</i>	28 mm	150 280 134
		36 mm	150 360 134
		38 mm	150 380 134
		40 mm	150 400 134
	4 Piece Centering Cone Set 1.65"- 5.20" (42mm – 132mm) <i>Includes Cones: 1, 2, 3 & 5</i>	28 mm	150 280 070
		36 mm	150 360 070
		38 mm	150 380 070
		40 mm	150 400 070
Recommended on Coats® balancers for maximum coverage			
	Centering Cone # 1 1.65"- 2.54" 42mm – 64.5mm	28 mm	150 280 008
		36 mm	150 360 008
		38 mm	150 380 008
		40 mm	150 400 008
	Centering Cone # 2 2.12"- 3.13" 54mm – 79.5mm	28 mm	150 280 009
		36 mm	150 360 009
		38 mm	150 380 009
		40 mm	150 400 009
	Centering Cone # 3 2.95"- 3.94" 74mm – 100mm	28 mm	150 280 010
		36 mm	150 360 010
		38 mm	150 380 010
		40 mm	150 400 010
	Centering Cone # 4 <i>(Tacoma Cone)</i> 2.95"- 4.39" 74mm – 111.5mm	28 mm	150 280 012
		36 mm	150 360 012
		38 mm	150 380 012
		40 mm	150 400 012
	Centering Cone # 5 3.50"- 5.20" 89mm – 132mm	28 mm	150 280 049
		36 mm	150 360 049
		38 mm	150 380 049
		40 mm	150 400 049
	Light Truck Cone Kit 4.72"- 6.85" 120mm – 174mm	28 mm	150 280 091
		36 mm	150 360 091
		38 mm	150 380 091
		40 mm	150 400 091
	Distance Spacer for Light Truck Cone Kit	28 mm	190 280 018
		36 mm	190 360 018
		38 mm	190 380 018
		40 mm	190 400 018

STANDARD TAPER CONES SECTION











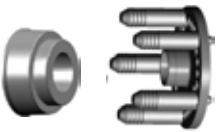

LOW TAPER CONES

Drawing	Description	Shaft Size	Part #
	<p>7 piece ultra low taper cone kit</p> <p>1.65" - 5.18" 42 mm - 131.6 mm</p>	<p>40 mm</p>	<p>15U 400 082</p>

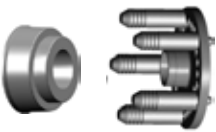
SET OF GAUGES AND MEASURING FORKS ("GO" AND "NO GO" GAUGES)

Drawing	Description	Part #
	<p>This kit includes all of the necessary measuring tools to help you determine the amount of wear that a balancer shaft or the cones and accessories may have in them. This kit allows you to show the customer that they may have worn out equipment that can directly affect the quality of every tire balance that comes through their shop.</p>	<p>900 008 076</p>









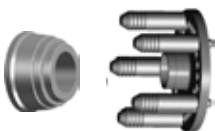

MANUFACTURER SPECIFIC

Drawing	Description	Shaft Size	Part #
	Direct fit Collets	Shaft Size	
	Direct fit Collet for Ford Covers 87 mm hub bores	28 mm 36 mm 38 mm 40 mm	150 280 094 150 360 094 150 380 094 150 400 094
	Direct fit Collet for Jeep 67.05 & 71.6 mm (New Double Sided) Covers all Jeep hub bores	28 mm 36 mm 38 mm 40 mm	160 280 057 160 360 057 160 380 057 160 400 057
	BMW Precision Kit Includes: 1 x BMW specific Flange Plate 5 x Spring Loaded Studs 1 x BMW Direct Fit Collet <i>(Studs are recommended by BMW Germany)</i>	28 mm 36 mm 38 mm 40 mm	280 280 269 280 360 269 280 380 269 280 400 269
	Flange Plate for BMW 4 x 100mm & 5 x 120mm	28 mm 36 mm 38 mm 40 mm	211e201 280 211e201 360 211e201 380 211e201 400
	Plug in Stud for BMW Plate 100 mm long, Spring Loaded <i>(Recommended by BMW Germany)</i>		271 994 208
	Direct fit Collet for BMW 57, 72.5, 74 mm Covers all BMW hub bores	28 mm 36 mm 38 mm 40 mm	160 280 031 160 360 031 160 380 031 160 400 031
	Mercedes Benz Precision Kit Includes: 1 x MB Specific Flange Plate 5 x Straight Taper Studs 1 x MB Direct Fit Collet	28 mm 36 mm 38 mm 40 mm	280 280 625 280 360 625 280 380 625 280 400 625
	Flange Plate for Mercedes Benz 3 x 112mm, 5 x 112, 130 & 140mm <i>(Includes bolt pattern for Smart Car)</i>	28 mm 36 mm 38 mm 40 mm	201e402 280 201e402 360 201e402 380 201e402 400
	Flange Plate for "Sprinter" With 6 Lug, Single Rear Wheels 6 x 120mm, 6 x 130mm SRX-Cadillac	28 mm 36 mm 38 mm 40 mm	260e112 280 260e112 360 260e112 380 260e112 400
	Plug in Stud 100 mm long, Straight Taper (12mm Pin)		271 994 012
	Plug in Stud for AMG wheels 100 mm long, Ball seat (12mm Pin)		271 994 002
	Direct fit Collet for Mercedes Benz 66.5, 84, 85 mm Covers all Mercedes Benz hub bores	28 mm 36 mm 38 mm 40 mm	160 280 051 160 360 051 160 380 051 160 400 051

MANUFACTURER SPECIFIC



MANUFACTURER SPECIFIC

MANUFACTURER SPECIFIC

Drawing	Description	Part #	
Shaft Size			
	Porsche Precision Kit Includes: 1 x Porsche Flange Plate 5 x Ball Seat Studs 1 x Porsche Direct Fit Collet	28 mm	280 280 767
		36 mm	280 360 767
		38 mm	280 380 767
		40 mm	280 400 767
	Flange Plate for Porsche 5 x 108mm	28 mm	250e105 280
		36 mm	250e105 360
		38 mm	250e105 380
		40 mm	250e105 400
	Plug in Stud 100 mm long, Ball seat (12mm Pin)	271 994 002	
	Direct fit Collet for Porsche 57.1 & 71.6 mm	28 mm	160 280 032
		36 mm	160 360 032
		38 mm	160 380 032
		40 mm	160 400 032
	Toyota / Lexus Precision Kit Cylindrical solution for hard to balance Toyota & Lexus wheels Includes: 6 x Conical Seat Toyota / Lexus Plates 1 & 2 Direct fit collets 1 & 2	28 mm	280 280 855
		36 mm	280 360 855
		38 mm	280 380 855
		40 mm	280 400 855
	Toyota / Lexus Plate #1 (5x100, 5x114.3, 6x139.7)	28 mm	231e301 283
		36 mm	231e301 363
		38 mm	231e301 383
		40 mm	231e301 403
	Toyota / Lexus Plate #2 (4x100, 5x120, 5x150)	28 mm	251e306 280
		36 mm	251e306 360
		38 mm	251e306 380
		40 mm	251e306 400
	Plug in Stud 99mm long, Conical seat (12mm Pin)	271 994 016	
	Direct fit Collet # 1 for select Lexus & Toyota models Covers 106 & 110 mm hub bores	28 mm	160 280 053
		36 mm	160 360 053
		38 mm	160 380 053
		40 mm	160 400 053
	Direct fit Collet # 2 for select Lexus, Nissan & Toyota models Covers 100 & 108 mm hub bores	28 mm	160 280 058
		36 mm	160 360 058
		38 mm	160 380 058
		40 mm	160 400 058

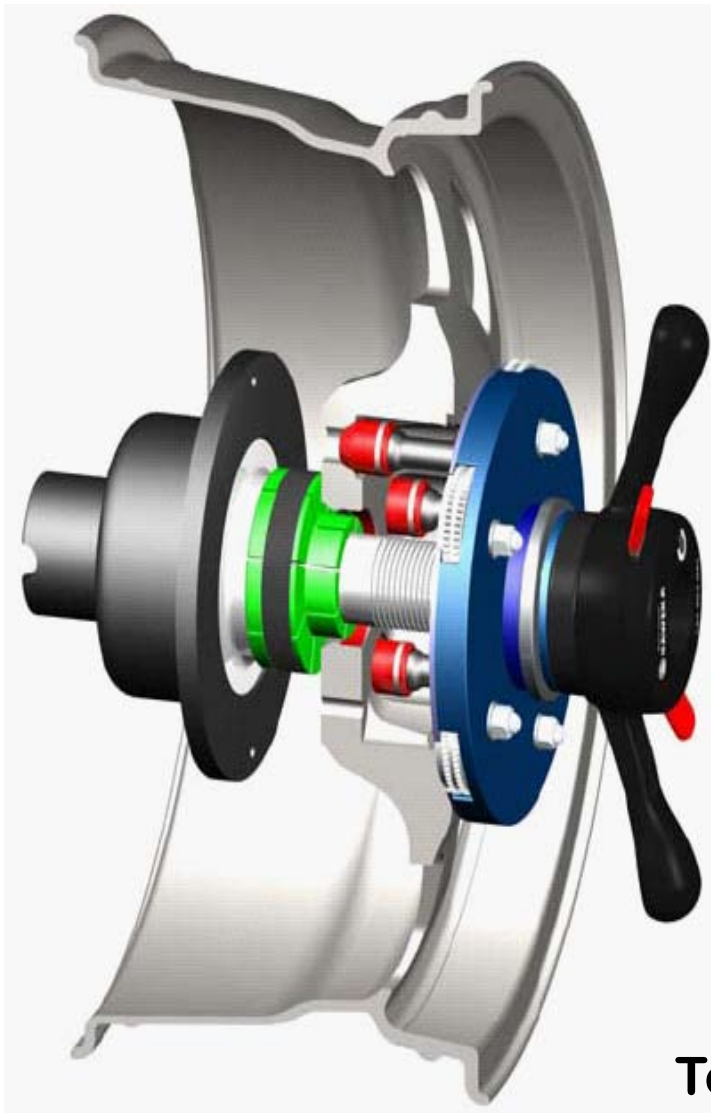
Balancing Technique for Passenger Cars, LT and SUV's



-  **Manufacturer Approvals**
-  **Patented, tolerance-free mid centering**
-  **Worldwide Supplier for all leading manufacturers of Balancing Machines**





Tolerance-free Mid Centering Device for Steel and Aluminium Rims



Experts in smooth riding vehicles

© 2010 Allpart Supply, Inc./Haweke USA

DUO COLLETS

Drawing	Description	Part #
	<p>Duo Collet</p> <p>Duo Collet System 3 collets w/ case</p> <p>Centering range: 54 – 85 mm (2.12" – 3.35")</p> <p>Includes Collets # 1, 2, & 3</p>	<p>Shaft Size</p> <p>28 mm 36 mm 38 mm 40 mm</p> <p>164 280 503 164 360 503 164 380 503 164 400 503</p>
	<p>Duo Collet # 1</p> <p>Centering range: 54 – 65 mm (2.12" – 2.56")</p>	<p>28 mm 36 mm 38 mm 40 mm</p> <p>164 280 501 164 360 501 164 380 501 164 400 501</p>
	<p>Duo Collet # 2</p> <p>Centering range: 64 – 75 mm (2.52" – 2.95")</p>	<p>28 mm 36 mm 38 mm 40 mm</p> <p>164 280 502 164 360 502 164 380 502 164 400 502</p>
	<p>Duo Collet # 3</p> <p>Centering range: 74 – 85 mm (2.91" – 3.35")</p>	<p>28 mm 36 mm 38 mm 40 mm</p> <p>164 280 507 164 360 507 164 380 507 164 400 507</p>
	<p>Support spacer for Duo Collet</p>	<p>28 mm 36 mm 38 mm 40 mm</p> <p>190 280 010 190 360 010 190 380 010 190 400 010</p>

PASSENGER CAR, LIGHT TRUCK AND SUV SECTION

PRO EXPERT KIT FOR 4, 5, AND 6 LUG WHEELS

Description	Kit Part #
<p>This Kit is all you need to work on any 4,5, or 6 Lug Bolt Pattern on any Passenger Car, Light Truck, or SUV!</p>	<p>PRO 456 280 PRO 456 360 PRO 456 380 PRO 456 400</p>

Drawing

4,5, and 6 Lug QuickPlates



**Duo Collet
54-65mm
clamping range**



**Duo Collet
64-75mm
clamping range**



**Duo Collet
74-85mm
clamping range**



Off-Road Centering Kit

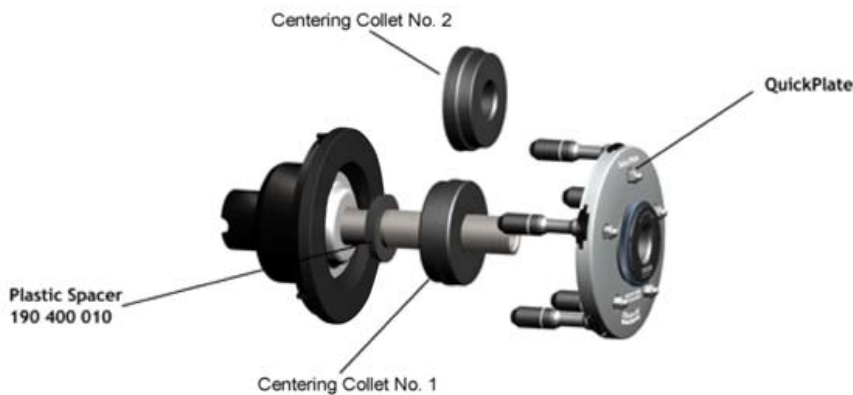

1 x Storage wallboard
(Stand sold separately)

- Kit includes:**
- 1 x Wallboard
 - 1 x 200 456 405 QuickPlate Kit (comes with a new stud configuration)
 - 1 x 164 400 503 Duo Collet Kit
 - 1 x Off Road Centering Collet I
 - 1 x Off Road Centering Collet II
 - 5 x 273e008 023 Tuner Studs

PASSENGER CAR, LIGHT TRUCK AND SUV SECTION

QUICKPLATE KITS FOR THREADED SHAFTS

Description	Part #
The QuickPlate kit includes a set of 3 Quick Plates and 1 wall board. Fully adjustable bolt circle from 95 - 182 mm. (3.75"-7.16") For all 4, 5, and 6-hole rims. No time-consuming search for the correct bolt circle. Interchangeable spring loaded heads for different lug types. Locking of the correct bolt circle via the new ProLoc-System.	200 456 285
	200 456 365
	200 456 385
	200 456 405

The QuickPlate kit includes the following items:



1 x Storage wallboard
(Stand sold separately)



1 x 4-lug QuickPlate



1 x 5-lug QuickPlate



1 x 6-lug QuickPlate









More styles available. See page 30

Optional wallboard stand is listed on page 34



Covers all current and FUTURE passenger vehicle bolt patterns!

INDIVIDUAL QUICKPLATES FOR THREADED SHAFTS

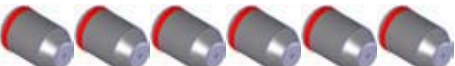





Drawing	Description	Part #
	<p>Quick Plate for 4 lug bolt patterns Bolt pattern range = 95 - 182 mm. (3.75"-7.16")</p> <p>This plate includes 1 set of standard tips</p> <p style="text-align: center;">4 x Part # 273e008 002</p> <p style="text-align: center;">  </p> <p>Description for standard tips: 24.5 mm diameter, short taper Overall length when installed = 70 mm (2.75")</p>	<p>249 009 280</p> <p>249 009 360</p> <p>249 009 380</p> <p>249 009 400</p>
	<p>Quick Plate for 5 lug bolt patterns Bolt pattern range = 95 - 182 mm. (3.75"-7.16")</p> <p>This plate includes 2 sets of standard tips</p> <p style="text-align: center;">5 x Part # 273e008 006</p> <p style="text-align: center;">  </p> <p style="text-align: center;">5 x Part # 273e008 011</p> <p style="text-align: center;">  </p> <p>Description for standard tips: 273e008 006: 24.5 mm diameter, Ball seat Overall length when installed = 80 mm (3.15")</p> <p>273e008 011: 22.5 mm diameter, long taper. Overall length when installed = 90 mm (3.5")</p>	<p>259 009 280</p> <p>259 009 360</p> <p>259 009 380</p> <p>259 009 400</p>
	<p>Quick Plate for 6 lug bolt patterns Bolt pattern range = 95 - 182 mm. (3.75"-7.16")</p> <p>This plate includes 1 set of standard tips</p> <p style="text-align: center;">6 x Part # 273e008 003</p> <p style="text-align: center;">  </p> <p>Description for standard tips: 24.5 mm diameter, short taper Overall length when installed = 80 mm (3.15")</p>	<p>269 009 280</p> <p>269 009 360</p> <p>269 009 380</p> <p>269 009 400</p>

PASSENGER CAR, LIGHT TRUCK AND SUV SECTION

QUICKPLATE KITS FOR POWER CLAMP SHAFTS

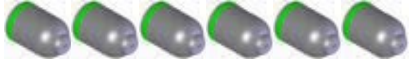
Description	Part #
Kit includes a set of 3 Quick Plates and 1 wall board. Fully adjustable bolt circle from 95 - 182 mm. (3.75"-7.16") For all 4, 5, and 6-hole rims. No time-consuming search for the correct bolt circle. Interchangeable spring loaded heads for different lug types. Locking of the correct bolt circle via the new ProLoc-System.	For Cemb 40mm Power Clamp 205 456 405
	For Hofmann & John Bean Power Clamp balancers 203 456 405

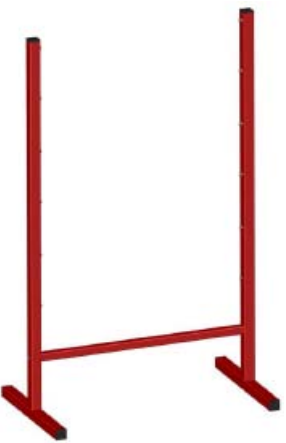
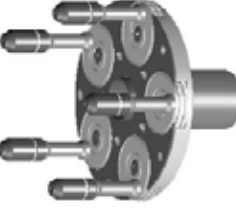





The QuickPlate kit includes the following items:

	<p>1 x Storage wallboard <i>(Stand sold separately)</i></p>	<p>6 x 273e008 002</p>  <p>6 x 273e008 003</p>  <p>6 x 273e008 006</p>  <p>6 x 273e008 011</p>  <p><i>More styles available. See page 30</i></p>
	<p>1 x 4-lug QuickPlate</p>	<p><i>Optional wallboard stand is listed on page 34</i></p> 
	<p>1 x 5-lug QuickPlate</p>	
	<p>1 x 6-lug QuickPlate</p>	

Covers all current and FUTURE passenger vehicle bolt patterns!

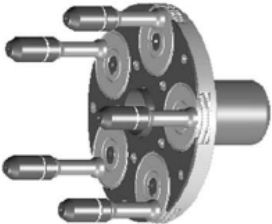
PASSENGER CAR, LIGHT TRUCK AND SUV SECTION

INDIVIDUAL QUICKPLATES FOR POWER CLAMP SHAFTS

Drawing	Description	Part #
	<p>Quick Plate for 4 lug bolt patterns Bolt pattern range = 95 - 182 mm. (3.75"-7.16")</p> <p>This plate includes 1 set of standard tips</p> <p>4 x Part # 273e008 002</p>  <p>Description for standard tips: 24.5 mm diameter, short taper Overall length when installed = 70 mm (2.75")</p>	<p>For Cemb 40mm Power Clamp 249 589 401</p> <p>For Hofmann & John Bean Power Clamp balancers 249 818 401</p>
	<p>Quick Plate for 5 lug bolt patterns Bolt pattern range = 95 - 182 mm. (3.75"-7.16")</p> <p>This plate includes 2 sets of standard tips</p> <p>5 x Part # 273e008 006</p>  <p>5 x Part # 273e008 011</p>  <p>Description for standard tips: 273e008 006: 24.5 mm diameter, Ball seat Overall length when installed = 80 mm (3.15")</p> <p>273e008 011: 22.5 mm diameter, long taper. Overall length when installed = 90 mm (3.5")</p>	<p>For Cemb 40mm Power Clamp 259 589 401</p> <p>For Hofmann & John Bean Power Clamp balancers 259 818 401</p>
	<p>Quick Plate for 6 lug bolt patterns Bolt pattern range = 95 - 182 mm. (3.75"-7.16")</p> <p>This plate includes 1 set of standard tips</p> <p>6 x Part # 273e008 003</p>  <p>Description for standard tips: 24.5 mm diameter, short taper Overall length when installed = 80 mm (3.15")</p>	<p>For Cemb 40mm Power Clamp 269 589 401</p> <p>For Hofmann & John Bean Power Clamp balancers 269 818 401</p>

PASSENGER CAR, LIGHT TRUCK AND SUV SECTION

DUO PLATE KITS

Description	Part #
<p>With the introduction of the Duo Plate, Haweka brings several new features which are unsurpassed in accuracy and functionality. Each flange plate now has a replaceable color coded, silver face, an all new design of the stud bore and studs which produce absolute zero tolerance once locked into place, and an all new tolerance free clamping collet feature to the center bore of the Duo Plate virtually eliminating remount errors.</p>	207 280 000
	207 360 000
	207 380 000
	207 400 000

The Duo Plate kit includes the following items:

See page 51 for bolt pattern listing



1 x Storage wallboard
(Stand sold separately)

10 x 274 008 001

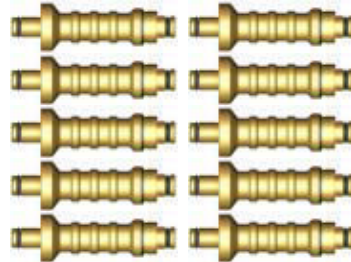

1 x Duo Plate # 1

7 x 273e008 002



1 x Duo Plate # 2

6 x 273e008 003



1 x Duo Plate # 3

6 x 273e008 006

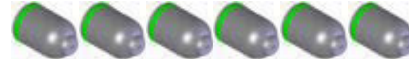

1 x Duo Plate # 4

6 x 273e008 011







More styles available. See page 30

Optional wallboard stand is listed on page 34











INDIVIDUAL DUO PLATES

Drawing	Description				Part #
 Duo Plate # 1	Bolt patterns in millimeters		Bolt patterns in Inches		247 701 287 247 701 367 247 701 387 247 701 407
	4 x 98	4 x 114.3	4 x 3.86"	4 x 4.5"	
	4 x 100	7 x 150	4 x 3.94"	7 x 5.9"	
	4 x 101.6	8 x 170	4 x 4"	8 x 6.69"	
	4 x 108		4 x 4.25"		
 Duo Plate # 2	Bolt patterns in millimeters		Bolt patterns in Inches		257 701 287 257 701 367 257 701 387 257 701 407
	5 x 98	5 x 120.65	5 x 3.86"	5 x 4.75"	
	5 x 108	5 x 135	5 x 4.25"	5 x 5.32"	
	5 x 110	5 x 154.95	5 x 4.33"	5 x 6.10"	
	5 x 115		5 x 4.53"		
 Duo Plate # 3	Bolt patterns in millimeters		Bolt patterns in Inches		257 901 287 257 901 367 257 901 387 257 901 407
	5 x 100	5 x 130	5 x 3.94"	5 x 5.12"	
	5 x 112	5 x 139.7	5 x 4.41"	5 x 5.5"	
	5 x 114.3	5 x 150	5 x 4.5"	5 x 5.9"	
	5 x 120	5 x 165.1	5 x 4.72"	5 x 6.5"	
	5 x 127		5 x 5"		
 Duo Plate # 4	Bolt patterns in millimeters		Bolt patterns in Inches		237 101 287 237 101 367 237 101 387 237 101 407
	3 x 98	6 x 130	3 x 3.56"	6 x 5.12"	
	3 x 112	6 x 132	3 x 4.41"	6 x 5.20"	
	6 x 114.3	6 x 135	6 x 4.5"	6 x 5.31"	
	6 x 115	6 x 139.7	6 x 4.53"	6 x 5.5"	
	6 x 127	8 x 165.1	6 x 5"	8 x 6.5"	
	Description Stud For Duo Plate				Part # 274 008 001





PASSENGER CAR, LIGHT TRUCK AND SUV SECTION

TIPS FOR DUO PLATES AND QUICKPLATES





Drawing	Description	Part #
	24.5 mm diameter, Short taper Total installed length = 70 mm (2.75")	273e008 002
	24.5 mm diameter, Short taper Total installed length = 80 mm (3.15")	273e008 003
	24.5 mm diameter, Short taper Total installed length = 90 mm (3.5")	273e008 004
	24.5 mm diameter, Ball Seat Total installed length = 80 mm (3.15") Used on Acura, Audi, BMW, Mercedes Benz, Porsche, Toyota, Honda, VW, & shank lug nuts	273e008 006
	24.5 mm diameter, Ball Seat Total installed length = 90 mm (3.5") Used on Acura, Audi, BMW, Mercedes Benz, Porsche, Toyota, Honda, VW, & shank lug nuts	273e008 007
	34 mm diameter, Land Rover tip Total installed length = 70 mm (2.75") Used on select Land Rover vehicles	273e008 008
	22.5 mm diameter, Long taper Total installed length = 90 mm (3.5")	273e008 011
	22.5 mm diameter, Long taper Total installed length = 100 mm (3.95")	273e008 025
	19 mm diameter, Long taper Total installed length = 100 mm (3.95") Required for aftermarket and Tuner wheels	273e008 023

On the tips for the Duo Plates, **Add 10 mm (.40")** for the Total Installed length because of the stud length.





INDIVIDUAL COLOR CODED FLANGE PLATES

Drawing	Description				Part #
 Flange Plate # 1	Bolt patterns in millimeters		Bolt patterns in Inches		241e801 289 241e801 369 241e801 389 241e801 409
	4 x 95.25	4 x 108	4 x 3.75"	4 x 4.25"	
	4 x 98	4 x 114.3	4 x 3.86"	4 x 4.5"	
	4 x 100	7 x 150	4 x 3.94"	7 x 5.9"	
	4 x 101.6	8 x 170	4 x 4"	8 x 6.69"	
 Flange Plate # 2	Bolt patterns in millimeters		Bolt patterns in Inches		251e701 289 251e701 369 251e701 389 251e701 409
	5 x 98	5 x 120.65	5 x 3.86"	5 x 4.75"	
	5 x 108	5 x 135	5 x 4.25"	5 x 5.32"	
	5 x 110	5 x 154.95	5 x 4.33"	5 x 6.10"	
	5 x 115		5 x 4.53"		
 Flange Plate # 3	Bolt patterns in millimeters		Bolt patterns in Inches		251e901 289 251e901 369 251e901 389 251e901 409
	5 x 100	5 x 130	5 x 3.94"	5 x 5.12"	
	5 x 112	5 x 139.7	5 x 4.41"	5 x 5.5"	
	5 x 114.3	5 x 150	5 x 4.5"	5 x 5.9"	
	5 x 120	5 x 165.1	5 x 4.72"	5 x 6.5"	
	5 x 127		5 x 5"		
 Flange Plate # 4	Bolt patterns in millimeters		Bolt patterns in Inches		231e101 289 231e101 369 231e101 389 231e101 409
	3 x 98	6 x 130	3 x 3.56"	6 x 5.12"	
	3 x 112	6 x 132	3 x 4.41"	6 x 5.20"	
	6 x 114.3	6 x 135	6 x 4.5"	6 x 5.31"	
	6 x 115	6 x 139.7	6 x 4.53"	6 x 5.5"	
	6 x 127	8 x 165.1	6 x 5"	8 x 6.5"	

PASSENGER CAR, LIGHT TRUCK AND SUV SECTION





Drawing	Individual Studs	Part #
	Stud I 19 mm Head diameter, 100 mm long For aftermarket & tuner rims	271 994 117
	Stud II 24.5 mm Head diameter, 80 mm long	271 804 118
	Stud III 24.5 mm Head diameter, 90 mm long For Ball Seat lug nuts & small shank lug nuts	271 904 119
	Stud IV 34 mm Head diameter, 80 mm long For Select Land Rover vehicles & large shank lug nuts	271 804 120
	Stud V 22.5 mm Head diameter, 100 mm long For most SUV's & Light Trucks	271 994 121



U.S. FLANGE PLATE KIT



Drawing	Description	Kit Part #
<p>HAWEKA The Inventor of Flange Plates since 1973</p>	<p>The US Flange Plate Adaptor Kit is the newest kit offered by Haweka in our never ending quest to provide quality balancing solutions.</p> <p>This kit comes complete with four different flange plates each with letters and bolt patterns engraved, the set also includes; three sets of studs (21 studs total), and a trolley to help keep the work area orderly and mobile.</p>	<p>40mm = 200 249 409 38mm = 200 249 389 36mm = 200 249 369 28mm = 200 249 289</p>
 <p>Vehicle Application Chart Included</p>	<p>Flange plate A 4-lug and 8-lug plate</p> <p>Flange plate B 5-lug plate</p> <p>Flange plate C 5-lug plate</p> <p>Flange plate D 6-lug plate</p> <p>8 x Stud II 24.5 mm Head diameter, 80 mm long</p> <p>5 x Stud III 24.5 mm Head diameter, 90 mm long (Ball seat)</p> <p>8 x Stud V 22.5 mm Head diameter, 100 mm long</p> <p>Optional Studs:</p> <p> Stud I 19 mm Head diameter, 100 mm long For aftermarket & tuner rims 271 994 117</p> <p> Stud IV 34 mm Head diameter, 80 mm long For Select Land Rover vehicles & large shank lug nuts 271 804 120</p>	<p>Trolley Included</p>  

PASSENGER CAR, LIGHT TRUCK AND SUV SECTION

INDIVIDUAL U.S. FLANGE PLATES









Drawing	Description		Part #
 Flange Plate A	Bolt patterns in millimeters	Bolt patterns in Inches	
	4 x 100	4 x 3.94"	241e605 289
	4 x 108	4 x 4.25"	241e605 369
	4 x 110	4 x 4.33"	241e605 389
	4 x 114.3	4 x 4.5"	241e605 409
	8 x 165.1 8 x 170	8 x 6.5" 8 x 6.69"	
 Flange Plate B	Bolt patterns in millimeters	Bolt patterns in Inches	
	5 x 100	5 x 3.94"	251e703 289
	5 x 110	5 x 4.33"	251e703 369
	5 x 114.3	5 x 4.5"	251e703 389
	5 x 120	5 x 4.72"	251e703 409
	5 x 127 5 x 135 5 x 150	5 x 5" 5 x 5.32" 5 x 5.9"	
 Flange Plate C	Bolt patterns in millimeters	Bolt patterns in Inches	
	5 x 108	5 x 4.25"	251e704 289
	5 x 112	5 x 4.41"	251e704 369
	5 x 115	5 x 4.53"	251e704 389
	5 x 120.65	5 x 4.75"	251e704 409
	5 x 130 5 x 139.7 5 x 165.1	5 x 5.12" 5 x 5.5" 5 x 6.5"	
 Flange Plate D	Bolt patterns in millimeters	Bolt patterns in Inches	
	6 x 114.3	6 x 4.5"	261e501 289
	6 x 115	6 x 4.53"	261e501 369
	6 x 127	6 x 5"	261e501 389
	6 x 132	6 x 5.20"	261e501 409
	6 x 135 6 x 139.7	6 x 5.31" 6 x 5.5"	

Drawing	Individual Studs	Part #
	Stud II 24.5 mm Head diameter, 80 mm long	271 804 118
	Stud III 24.5 mm Head diameter, 90 mm long For Ball Seat lug nuts & small shank lug nuts	271 904 119
	Stud V 22.5 mm Head diameter, 100 mm long For most SUV's & Light Trucks	271 994 121

Drawing	Optional Studs	Part #
	Stud I 19 mm Head diameter, 100 mm long For aftermarket & tuner rims	271 994 117
	Stud IV 34 mm Head diameter, 80 mm long For Select Land Rover vehicles & large shank lug nuts	271 804 120

PASSENGER CAR, LIGHT TRUCK AND SUV SECTION

GENERAL OPTIONS AND ACCESSORIES

Drawing	Description	Part #
	Wall Board for Duo Plates	900 008 195
	Wall Board for US Flange Plates	900 008 154
	Wall Board "Stand" Storage solution for World Kits, Off Road kits, Quick Plate kits, FixPlate Kits and Pro Bike kits.	900e008 190
	"Trolley" (For 38, 36, 28mm flange Plate Systems) Flange plate storage solution with perforated plate for pin storage.	900 008 133
	"Trolley" (For 40mm flange Plate Systems) Flange plate storage solution with perforated plate for pin storage.	900 008 127
	Width Measurement Calliper	900 008 005
	Wheel Weight Pliers	900 008 006
	Back Cone Spring for 40, 38, & 36 mm shafts	190 400 015
	Back Cone Spring for 28 mm shafts	190 280 015

Haweke Medium Duty Adaptors are specially designed for Medium Duty Truck Wheels

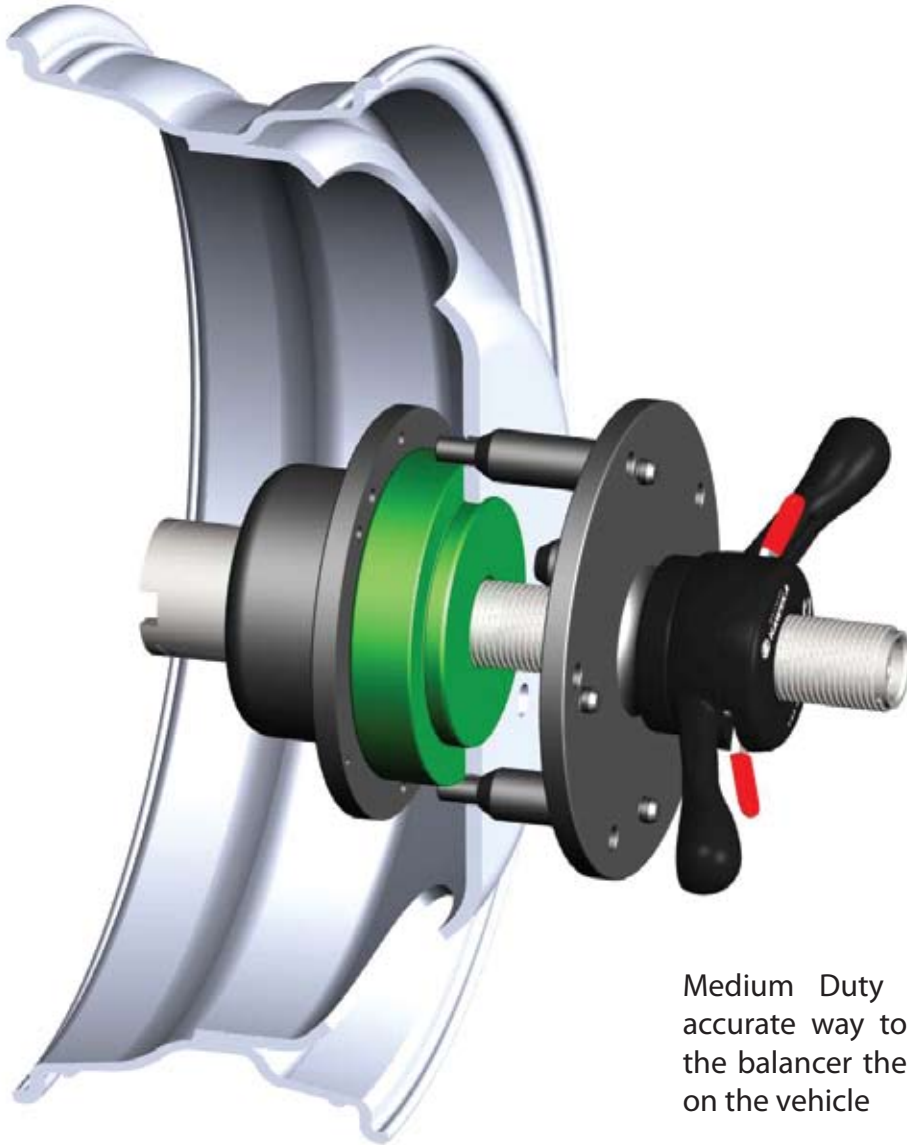

Medium Duty Kits provide the most accurate way to mount the wheel onto the balancer the same way it is mounted on the vehicle

Its special design centers the wheel by the bolt holes in conjunction with the center bore, to guarantee a perfect run out of the wheel on the balancer.

The centering studs are designed to reach through the rim's bolt holes to be supported by the circumference of the centering disc to support and compensate for the weight of the wheel.

Even the heaviest wheel will be securely locked onto the balancer to provide a basis for a consistent and extremely precise balancing result.

PRO-MAX 8 & 10 LUG ADAPTOR KIT

Drawing	Description	Part #
	<p>Covers all 8 & 10 lug bolt patterns and hub bores from Chevrolet, Dodge & Ford cylindrically.</p> <p>Haweka's centering discs are an exact replica of the hub diameter found on all medium duty vehicles.</p> <p>Both the hub and lug nuts are replicated perfectly which allows you to achieve superior balancing results over any adapter system available.</p> <p style="text-align: center;">Includes Lug Adapters # 1-3 Includes Hub Pilot Discs # 1-6</p>	<p>280 280 063</p> <p>280 360 063</p> <p>280 380 063</p> <p>280 400 063</p>

PRO-MAX 6 LUG ADAPTOR KIT

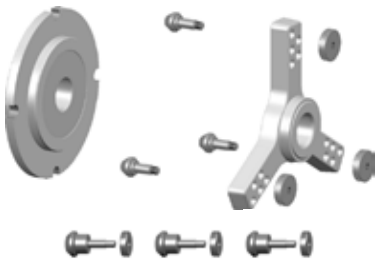
Drawing	Description	Part #
	<p>Kit covers all "Sprinter" style vans <u>with dual wheels</u> & Isuzu NPR / NQR style vehicles</p> <p>Bolt patterns: 6 x 8.07" (205 mm) 6 x 8.75" (222.25 mm)</p>	<p>280 280 061</p> <p>280 360 061</p> <p>280 380 061</p> <p>280 400 061</p>

PERFECT FOR GOVERNMENT SERVICE
AND AMBULANCE FLEETS

Covers all Medium Duty vehicles with an 8 x 6.5" bolt pattern

Drawing	Specialty centering kit for 8 x 6.5" bolt patterns	Part #
	<p>Centering cone range: 4.48" - 4.98" (114 - 126.5 mm)</p> <p>Flange plate bolt pattern: 8 x 6.5"</p> <p>Universal adaptor with spring loaded cone, backing plate, and flange plate.</p>	<p>280 400 044</p>

PRO-MAX ADAPTOR KIT-CHEVROLET

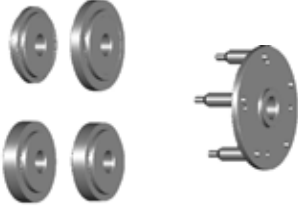
Drawing	Description	Part #
	<p>Covers all Chevrolet 8 & 10 lug medium duty</p> <p>Designed especially for Chevrolet medium duty vehicles.</p> <p>Both the hub and lug nuts are replicated perfectly which allows you to achieve superior balancing results over any adapter system available.</p> <p>Chevrolet Bolt Patterns: 8 x 6.5" 10 x 7.25"</p> <p>Includes Lug Adapter # 1 Includes Hub Pilot Discs # 1, 3, 4, 5</p>	<p>280 280 100</p> <p>280 360 100</p> <p>280 380 100</p> <p>280 400 100</p>

PRO-MAX ADAPTOR KIT-DODGE 1

Drawing	Description	Part #
	<p>Covers all Dodge 8 & 10 lug medium duty</p> <p>Designed especially for Dodge medium duty vehicles.</p> <p>Both the hub and lug nuts are replicated perfectly which allows you to achieve superior balancing results over any adapter system available.</p> <p>Dodge Bolt Patterns: 8 x 6.5" 10 x 225mm (8.86")</p> <p>Includes Lug Adapters # 1 & 3 Includes Hub Pilot Discs # 2 & 6</p>	<p>280 280 062</p> <p>280 360 062</p> <p>280 380 062</p> <p>280 400 062</p>

PRO-MAX ADAPTOR KIT-DODGE 2

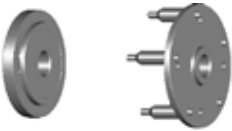
Drawing	Description	Part #
	<p>Covers all Dodge 8 lug medium duty</p> <p>Designed especially for Dodge medium duty vehicles.</p> <p>Both the hub and lug nuts are replicated perfectly which allows you to achieve superior balancing results over any adapter system available.</p> <p>Dodge Bolt Patterns: 8 x 6.5"</p> <p>Includes Lug Adapter # 1 Includes Hub Pilot Disc # 6</p>	<p>280 280 201</p> <p>280 360 201</p> <p>280 380 201</p> <p>280 400 201</p>

MEDIUM DUTY SECTION

PRO-MAX ADAPTOR KIT-FORD 1

Drawing	Description	Part #
	<p>Covers All Ford 8 & 10 lug medium duty</p> <p>Designed especially for Ford medium duty vehicles. Both the hub and lug nuts are replicated perfectly which allows you to achieve superior balancing results over any adapter system available.</p>	<p>280 280 300</p> <p>280 360 300</p> <p>280 380 300</p> <p>280 400 300</p>
	<p>Ford Bolt Patterns: 8 x 6.5" 10 x 7.25" 8 x 170mm 10 x 225mm 8 x 200mm 8 x 225mm</p>	
	<p>Includes Lug Adapters # 1, 2, 3 Includes Hub Pilot Discs # 1, 2, 3</p>	

PRO-MAX ADAPTOR KIT-FORD 2

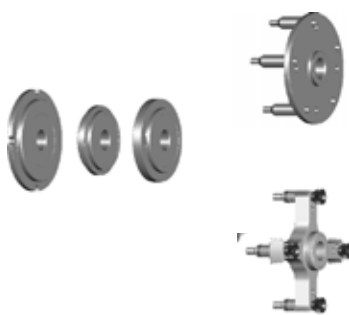







Drawing	Description	Part #
	<p>Covers Ford 8 & 10 lug medium duty (Excludes 10 x 225)</p> <p>Designed especially for Ford medium duty vehicles. Both the hub and lug nuts are replicated perfectly which allows you to achieve superior balancing results over any adapter system available.</p>	<p>280 280 301</p> <p>280 360 301</p> <p>280 380 301</p> <p>280 400 301</p>
	<p>Ford Bolt Patterns: 8 x 6.5" 10 x 7.25" 8 x 170mm 8 x 200mm 8 x 225mm</p>	
	<p>Includes Lug Adapters # 1 & 2 Includes Hub Pilot Discs # 1, 2, 3</p>	

PRO-MAX ADAPTOR KIT-10 X 225

Drawing	Description	Part #
	<p>Covers New Ford F-450 / 550 & LCF Trucks & New Sterling Bullet & Dodge Ram 4500 / 5500</p> <p><i>(Included in Dodge Kit 1 280 xx0 062)</i> <i>(Included in Ford Kit 1 280 xx0 062)</i></p> <p>Both the hub and lug nuts are replicated perfectly which allows you to achieve superior balancing results over any adapter system available.</p>	<p>280 280 501</p> <p>280 360 501</p> <p>280 380 501</p> <p>280 400 501</p>
	<p>Ford & Dodge Bolt Patterns: 10 x 225mm (8.86")</p>	
	<p>Includes Lug Adapter # 3 Includes Hub Pilot Disc # 2</p>	

MEDIUM DUTY SECTION

PRO-MAX SERIES ADAPTOR SPARE PARTS

Drawing	Description	Adapter	Part #
	Flange Plate Lug Adapter 8 x 6.5" (165.1 mm) 10 x 7.25" (184.15 mm)	Lug Adaptor # 1	251 206 280 MD 251 206 360 MD 251 206 380 MD 251 206 400 MD
	4 Arm Lug Adapter For Bolt Patterns: 8 x 6.69" (170 mm) 8 x 7.87" (200 mm) 8 x 8.86" (225 mm)	Lug Adaptor # 2	700 280 011 MD 700 360 011 MD 700 380 011 MD 700 400 011 MD
	5 Arm Lug Adapter For Bolt Patterns: 10 x 8.86" (225 mm)	Lug Adaptor # 3	700 280 004 MD 700 360 004 MD 700 380 004 MD 700 400 004 MD
	Hub Pilot Disc (Double Sided) For Hub Bores: 4.88" (123.95 mm) 4.92" (125.1 mm)	# 1	160 280 047 160 360 047 160 380 047 160 400 047
	Hub Pilot Disc (Double Sided) For Hub Bores: 5.59" (142.1 mm) 6.69" (170.1 mm)	# 2	160 280 048 160 360 048 160 380 048 160 400 048
	Hub Pilot Disc (Double Sided) For Hub Bores: 5.46" (138.65 mm) 5.25" (133.35 mm)	# 3	190 280 052 190 360 052 190 380 052 190 400 052
	Hub Pilot Disc (Single Sided) For Hub Bore: 4.56" (115.8 mm)	# 4	190 280 060 190 360 060 190 380 060 190 400 060
	Hub Pilot Disc (Single Sided) For Hub Bore: 4.6" (116.8 mm)	# 5	190 280 062 190 360 062 190 380 062 190 400 062
	Hub Pilot Disc (Single Sided) For Hub Bore: 4.77" (121.1 mm)	# 6	190 280 071 190 360 071 190 380 071 190 400 071

MEDIUM DUTY SECTION

AIRGO LIFT

AIRGO LIFT FOR MEDIUM AND HEAVY DUTY

Drawing	Description	Part #
	<p style="text-align: center;"><i>HAWEKA Wheel Lift</i> <i>A benefit for any shop</i></p> <p>Pneumatic wheel lifting platform for all balancers</p> <p>Save your back and prevent unnecessary damage to the balancer shaft, centering adaptors, and customer's wheels when you use the Haweka Wheel Lift.</p> <p>Eliminate wheels being dropped onto the balancer shaft or adaptors that can result in expensive parts replacement and service calls to repair the equipment.</p> <p>Foot pedal controls allow hands free operation.</p> <p>Virtually eliminate operator fatigue during the mounting and demounting of wheel assemblies from the balancer.</p> <p>Max. lifting height = 15" Platform sliding range = 18"</p> <p>Max lifting capacity = 155 Lbs. Shipping weight = 100 Lbs.</p>	<p style="text-align: center;">916 000 014</p>

TRUCK WHEEL ADAPTORS



SEMI TRUCK / BUS KITS FOR ALL 40MM TRUCK WHEEL BALANCERS



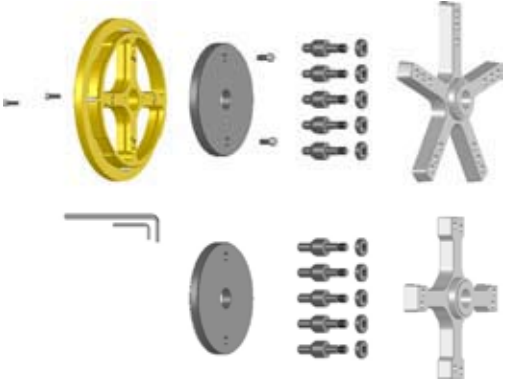

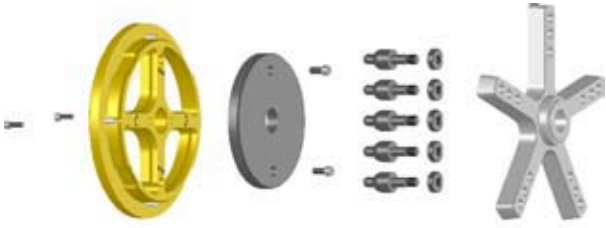



SEMI TRUCK / BUS ADAPTORS SECTION

Drawing	
	
Description	Part #
<p>Master Semi Truck / Bus Adaptor Kit (8 x 275 / 285, 10 x 285.75 / 335)</p> <p>Included in this kit:</p> <ul style="list-style-type: none"> HD 4 Arm Star HD 5 Arm Star (5 x) Studs for Steel wheels (5 x) Studs for Aluminum wheels Basic Truck Adaptor II Stud Piloted Wheel Centering Disc Hub Piloted Wheel Centering Disc 	<p>700 400 193</p>

Drawing	
	
Description	Part #
<p>Standard Semi Truck / Bus Adaptor Kit (10 x 285.75 / 335)</p> <p>Included in this kit:</p> <ul style="list-style-type: none"> HD 5 Arm Star (5 x) Studs for Steel wheels Basic Truck Adaptor II Hub Piloted Wheel Centering Disc 	<p>700 400 522</p>

SPARE PARTS

40MM SEMI TRUCK / BUS

Drawing	Description	Part #
	<p>(Includes 5 studs for steel wheels)</p> <p>HD 5 Arm Star for Semi Trucks and Buses</p> <p>For bolt patterns: 10 x 8.86" (225 mm) 10 x 11.25" (285.75 mm) 10 x 13.19" (335 mm)</p>	700 400 004
	<p>(Studs not included)</p> <p>HD 4 Arm Star for Semi Trucks and Buses</p> <p>For bolt patterns: 8 x 10.83" (275 mm) 8 x 11.22" (285 mm)</p>	700e400 005
	<p>Universal Steel Spacer</p> <p>This adaptor allows spacing of the adaptors and wheel away from the balancer to help with clearance issues.</p>	190e988 003
	<p>Basic Semi Truck Adaptor II</p> <p>Centering disc for European style Semi / Bus wheels with 11.06" (281mm) Hub bore. Stud support plate for U.S. style Semi / Bus wheels</p>	700e958 113
	<p>Stud Pilot Centering Disc for Semi Truck wheels Center Bore: 220.8 mm (8.69")</p>	70Be958 007
	<p>Hub Pilot Centering Disc for Semi Truck wheels Center Bore: 219.9 mm (8.66")</p>	70Be958 008
	<p>Standard centering stud for steel wheels. (Semi Trucks)</p>	700 008 003
	<p>Centering stud required for aluminium wheels (Semi Trucks)</p>	700 008 006

COATS 640I SEMI TRUCK / BUS KITS

Drawing

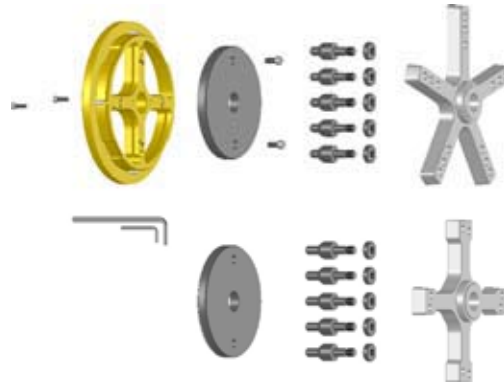

Description

Part

Master Semi Truck / Bus Adaptor Kit (8 x 275 / 285, 10 x 285.75 / 335)

Included in this kit:

- HD 4 Arm Star
- HD 5 Arm Star
- (5 x) Studs for Steel wheels
- (5 x) Studs for Aluminum wheels
- Basic Truck Adaptor II
- Stud Piloted Wheel Centering Disc
- Hub Piloted Wheel Centering Disc

700 510 193

Drawing

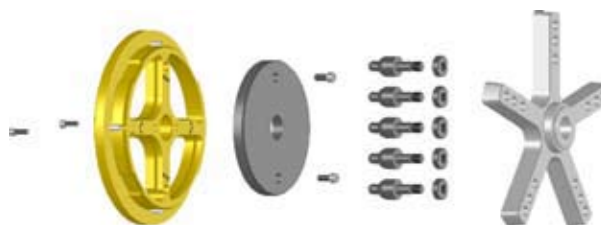

Description

Part

Standard Semi Truck / Bus Adaptor Kit (10 x 285.75 / 335)







Included in this kit:

- HD 5 Arm Star
- (5 x) Studs for Steel wheels
- Basic Truck Adaptor II
- Hub Piloted Wheel Centering Disc

700 510 522





SEMI TRUCK / BUS ADAPTORS SECTION

SPARE PARTS COATS 6401 SEMI TRUCK / BUS

Drawing	Description	Part #
	<p>(Includes 5 studs for steel wheels)</p> <p>HD 5 Arm Star for Semi Trucks and Buses</p> <p>For bolt patterns: 10 x 8.86" (225 mm) 10 x 11.25" (285.75 mm) 10 x 13.19" (335 mm)</p>	700 510 004
	<p>(Studs not included)</p> <p>HD 4 Arm Star for Semi Trucks and Buses</p> <p>For bolt patterns: 8 x 10.83" (275 mm) 8 x 11.22" (285 mm)</p>	70Be510 005
	<p>Basic Semi Truck Adaptor II</p> <p>Centering disc for European style Semi / Bus wheels with 11.06" (281mm) Hub bore. Stud support plate for U.S. style Semi / Bus wheels</p>	700e888 113
	<p>Stud Pilot Centering Disc for Semi Truck wheels Center Bore: 220.8 mm (8.69")</p>	700e798 007
	<p>Hub Pilot Centering Disc for Semi Truck wheels Center Bore: 219.9 mm (8.66")</p>	700e798 008
	<p>Standard centering stud for steel wheels. (Semi Trucks)</p>	700 008 003
	<p>Centering stud required for aluminium wheels (Semi Trucks)</p>	700 008 006

SEMI TRUCK / BUS ADAPTORS SECTION

TRILEX / DAYTON ADAPTORS

Drawing	Description	Part #
	Trilex Adaptor 20" / 24", Fisher / Dayton	725 400 001
	Trilex Adaptor 20" / 22.5" / 24", Europa	725 400 002
	Trilex Adaptor 20" / 24", Fisher / Dayton	725 460 001
	Trilex Adaptor 20" / 22.5" / 24", Europa	725 460 002

Pro Bike II – Series 805









The Motorcycle Clamping Device



MOTORCYCLE KITS

Drawing	Description	Kit Part #
The Pro Bike II Standard kit includes the following sleeves sets: 15, 16, 17, 19, 20, 22, 25, 28mm		
 <p data-bbox="141 700 433 784"><i>Stand for wall boards sold separately on page 40</i></p>	Pro Bike II Modular System STANDARD (For Conical Connection)	805 818 000
	Pro Bike II Modular System STANDARD (For Coats 28 mm Connection)	805 937 000
	Pro Bike II Modular System STANDARD (For 28 mm Connection)	805 280 000
	Pro Bike II Modular System STANDARD (For 36 mm Connection)	805 360 000
	Pro Bike II Modular System STANDARD (For 38 mm Connection)	805 380 000
	Pro Bike II Modular System STANDARD (For 40 mm Connection)	805 400 000
The Pro Bike II Upgrade kit includes the following sleeve sets: 24, 25, 25.4, 28, 32, 35mm		
	Pro Bike II Modular System Professional Upgrade Kit (For all Conical Connections) (Includes all adaptors for Mono Lever swing arms)	805 818 001
	Pro Bike II Modular System Professional Upgrade Kit (For all Cylindrical Connections) (Includes all adaptors for Mono Lever swing arms)	805 008 001
“Custom Motorcycle Kits”		
The Pro Bike II “Custom Motorcycle Kit” includes the following sleeve set: 25 & 25.4mm (1”)		
	Pro Bike II Custom Motorcycle Kit (For Conical Connection)	805 818 014
	Pro Bike II Custom Motorcycle Kit (For Coats 28 mm Connection)	805 937 014
	Pro Bike II Custom Motorcycle Kit (For 28 mm Connection)	805 280 014
	Pro Bike II Custom Motorcycle Kit (For 36 mm Connection)	805 360 014
	Pro Bike II Custom Motorcycle Kit (For 38 mm Connection)	805 380 014
	Pro Bike II Custom Motorcycle Kit (For 40 mm Connection)	805 400 014

MOTORCYCLE CENTERING SLEEVES

Drawing	Description	Part #
Set of 2 centering sleeves for 14 mm shafts		
	Outer Diameter = 15 mm	860 140 150
	Outer Diameter = 16 mm	860 140 160
	Outer Diameter = 17 mm	860 140 170
	Outer Diameter = 19 mm	860 140 190
	Outer Diameter = 20 mm	860 140 200
	Outer Diameter = 22 mm	860 140 220
	Outer Diameter = 25 mm	860 140 250
	Outer Diameter = 28 mm	860 140 280
	Outer Diameter = 30 mm	860 140 300
	Centering Cone for 14 mm shafts (2 Required) Range of coverage: 14.75 - 30 mm	850e140 001
Set of 2 centering sleeves for 19 mm shafts		
	Outer Diameter = 22 mm	860 190 220
	Outer Diameter = 24 mm	860 190 240
	Outer Diameter = 25 mm	860 190 250
	Outer Diameter = 25.4 mm	860 190 014
	Outer Diameter = 28 mm	860 190 280
	Outer Diameter = 30 mm	860 190 300
	Outer Diameter = 32 mm	860 190 320
	Outer Diameter = 35 mm	860 190 350
	Adaptor for Mono lever swing arms on BMW (For 14 mm shafts only) Use with an 860e140 006 listed on page 43 .	860e141 005
	Adaptor for Mono lever swing arms on Ducati / Triumph Use with an 850e190 001 listed on page 43 .	860e190 004
	Adaptor for Mono lever swing arms on Honda NTV / GL 1800 Use with an 850e190 001 listed on page 43 .	860e190 008
	Adaptor for Mono lever swing arms on MV Agusta F-4 / 750 Strada Use with an 850e190 001 listed on page 43 .	860e190 011
	Adaptor for Mono lever swing arms on Aprilia / BMW / Yamaha Use with an 850e190 001 listed on page 43 .	860e190 012

ACCESSORIES & UPGRADES FOR MOTORCYCLE KITS

Drawing	Description	Part #
	Extra long 14 mm Shaft for <i>Cylindrical</i> Connections Usable Length = 11.5"	870 010 141
	Extra Long 19 mm Shaft for <i>Cylindrical</i> Connections Usable Length = 13.25"	870 010 191
	Extra long 14 mm Shaft for <i>Conical</i> Connection Usable Length = 11"	870 997 141
	Extra long 19 mm Shaft for <i>Conical</i> Connections Usable Length = 13.5"	870 997 191
	Quick Fix Clamping tool for 14 mm Shafts	890 140 001
	Quick Fix Clamping tool for 19 mm Shafts	890 190 001
	Special pressure piece For 14 mm shafts only.	860e140 006
	Special Centering cone For 19 mm shafts only.	850e190 001
	Spacer sleeve for 14 mm shafts (Total length = 20 mm)	860 150 002
	Set of 2 spacer sleeves for 19 mm shafts (Total length = 35 mm)	860 190 007



PARTS LIST BOLT PATTERN REFERENCE GUIDE



Bolt Pattern in Inches	Bolt Pattern in millimeters	Located on page
3 x 3.56"	3 x 98	29, 31
3 x 4.41"	3 x 112	19, 29, 31
4 x 3.86"	4 x 98	29, 31
4 x 3.94"	4 x 100	19, 20, 29, 31, 33
4 x 4"	4 x 101.6	29, 31
4 x 4.25"	4 x 108	29, 31, 33
4 x 4.5"	4 x 114.3	29, 31, 33
5 x 3.86"	5 x 98	29, 31
5 x 3.94"	5 x 100	20, 29, 31, 33
5 x 4.25"	5 x 108	20, 29, 31, 33
5 x 4.33"	5 x 110	29, 31, 33
5 x 4.41"	5 x 112	19, 29, 31, 33
5 x 4.5"	5 x 114.3	20, 29, 31, 33
5 x 4.53"	5 x 115	29, 31, 33
5 x 4.72"	5 x 120	19, 20, 29, 31, 33
5 x 4.75"	5 x 120.65	29, 31, 33
5 x 5"	5 x 127	29, 31, 33
5 x 5.12"	5 x 130	19, 29, 31, 33
5 x 5.32"	5 x 135	29, 31, 33
5 x 5.5"	5 x 139.7	29, 31, 33
5 x 5.51"	5 x 140	19
5 x 5.9"	5 x 150	29, 31, 33
5 x 6.10"	5 x 154.95	29, 31
5 x 6.5"	5 x 165.1	29, 31, 33
6 x 4.5"	6 x 114.3	29, 31, 33
6 x 4.53"	6 x 115	29, 31, 33
6 x 5"	6 x 127	29, 31, 33
6 x 5.12"	6 x 130	19, 29, 31
6 x 5.20"	6 x 132	29, 31, 33
6 x 5.31"	6 x 135	29, 31, 33
6 x 5.5"	6 x 139.7	20, 29, 31, 33
6 x 8.07"	6 x 205	36
6 x 8.75"	6 x 222.25	36
7 x 5.9"	7 x 150	29, 31
8 x 6.5"	8 x 165.1	29, 31, 33, 36, 37, 38, 39
8 x 6.69"	8 x 170	29, 31, 33, 36, 38, 39
8 x 7.87"	8 x 200	38, 39
8 x 8.86"	8 x 225	38, 39
10 x 10.83"	8 x 275	42, 43, 44
10 x 11.22"	8 x 285	42, 43, 44
10 x 7.25"	10 x 184.15	37, 38, 39
10 x 8.86"	10 x 225	37, 38, 39, 43, 44
10 x 11.22"	10 x 285	42, 43, 44, 45
10 x 13.19"	10 x 335	42, 43, 44, 45

Wheel Alignment Clamps



 original HAWEKA
MADE IN GERMANY

PROCLAMPS WITH SPRING-LOADED FEET

Drawing	Description	Part #
	<p>ProClamp Plus (with spring-loaded feet)</p> <p>Set: (4 Pieces) ProClamp Plus for.....aligner</p>	<p>918 XXX 543</p>
	<p>ProClamp Syncro (with spring-loaded feet)</p> <p>Set: (4 Pieces) ProClamp Syncro for.....aligner including attachment shafts</p>	<p>925 XXX 543</p>



ProClamp Plus



ProClamp Syncro



2201 E Loop 820 N, Fort Worth , 76118

www.allpartsupply.com

1- 800- 381-1330

FAX 817-284-2935